



CERTIFICATE OF APPROVAL

No CF 5319

This is to certify that, in accordance with
TS00 General Requirements for Certification of Fire Protection Products
The undermentioned products of

PYROGUARD UK LIMITED

International House, Millfield Lane, Haydock, WA11 9GA
Tel: 01942 710720 Fax: 01942 710730

Have been assessed against the requirements of the Technical Schedule(s)
denoted below and are approved for use subject to the conditions
appended hereto:

CERTIFIED PRODUCT

Pyroguard "Firesafe" T Range
of Integrity Control Fire
Resisting Glass

TECHNICAL SCHEDULE

TS 25 Fire Resistant Glass,
Glazing Systems and Materials

Signed and sealed for and on behalf of Warringtonfire Testing and Certification Limited

Paul Duggan
Certification Manager



Issued: 21st May 2015
Revised: 8th April 2021
Valid to: 27th May 2025





CERTIFICATE No CF 5319

PYROGUARD UK LIMITED

This certification is provided to the client for its own purposes and we cannot opine on whether it will be accepted by Building Control authorities or any other third parties for any purpose. This Certificate of Approval must be read in conjunction with CERTIFIRE Technical Schedule TS25, Fire Resistant Glass, Glazing Systems and Materials.

Pyroguard “Firesafe” T Integrity only (E) Fire Resisting Glass

This Certificate of Approval relates to the fire resistance of Pyroguard UK Ltd, Pyroguard “Firesafe” T monolithic, laminated products and double and triple Insulating Glass Units (IGUs) when used in the following applications, as defined in BS 476: Part 22: 1987 but using test results achieved against the following Standards - BS EN 1363-1 Fire Resistance Tests, BS EN 1363-2 Fire Resistance Tests additional or substitute procedures or BS EN 1364-1 1364-3 Fire Resistance Tests for Non Loadbearing Elements

This product is approved on the basis of:

- a) Initial type testing
- b) A design appraisal against TS25
- c) Product surveillance under BS EN ISO 9001: 2008
- d) Audit testing
- e) Inspection and surveillance of factory production control

Definition of Pyroguard terms:

VI – Double Glazed Unit “Vitrage Isolant”
TVI – Triple Glazed Unit “Triple Vitrage Isolant”
VF – Laminated “Vitrage Feuilleté”
RV – Double Sided “Recto Verso”
SWS – Structural Wall System

Signed
D/007 – E/308

Page 2 of 35

Issued: 21st May 2015
Revised: 8th April 2021
Valid to: 27th May 2025



CERTIFICATE No CF 5319 PYROGUARD UK LIMITED

Pyroguard T Integrity only (E) Fire Resisting Glass

Glass Specification	Application	Integrity	Page No.
Pyroguard T-E30/8/10/12/19	Hardwood framed screens	30	6-7
Pyroguard T-EW30/6 or Pyroguard T-EW30/6 VI RV (IGU) †*	Hardwood framed screens	30	8-9
Pyroguard T-EW30/6 †	Single Steel framed screens	30	10
Pyroguard T-E30/6/8/10/12/19	Single Steel framed screens	30	11
Pyroguard T-E30/10/12/19	Multiple Paned Steel framed screens	30	12
Pyroguard T-EW30/6 VI (IGU) †*	Multiple Paned Steel framed screens	30	13
Pyroguard T-EW30/6 or Pyroguard T-EW30/6 VI RV (IGU) †*	Multiple Paned Steel framed screens	30	14
Pyroguard T-EW30/6 VI RV (IGU) †*	Multiple Paned Steel framed screens	30	15
Pyroguard T-E30/6 VI (IGU) *	Multiple Paned Steel framed screens	30	16
Pyroguard T-E30/6 VI RV (IGU) †*	Multiple Paned Steel framed screens	30	17
Pyroguard T-E30/6/8/10/12/19, with option of sandblasted glass on fire side and non – fire side	Multiple Paned Steel framed screens	30	18
Pyroguard T-E30/6/8/10/12/19, with option of printed glass on fire side or non – fire side, print cover of up to 50% of area allowed	Multiple Paned Steel framed screens	30	19
Pyroguard T-E30/6/8/10/12/19 VF RV, with option of printed glass on fire side or non – fire side, print cover of up to 50% of area allowed †	Multiple Paned Steel framed screens	30	20
Pyroguard T- E30/6/8/10/12/19	Timber based doorsets	30	21-24
Pyroguard T-EW60/6 RV (66.2) †	Timber based doorsets	60	25
Pyroguard T-EW60/6 VI VF RV (IGU) †	Timber based doorsets	60	26

† **Note 1:** Not approved for manufacture at site E/308

***Note 2:** The fire resistant pane of the IGU construction can be used as a single glazed pane in any previously fire tested or CERTIFIRE approved system. In this case the product code will change.

Signed
D/007 – E/308

Page 3 of 35

Issued: 21st May 2015
Revised: 8th April 2021
Valid to: 27th May 2025



CERTIFICATE No CF 5319 PYROGUARD UK LIMITED

Pyroguard T Integrity only (E) Fire Resisting Glass (continued)

Glass Specification	Application	Integrity	Page No.
Pyroguard T-EW60/6 TVI (TGU) †	Multiple Paned Steel framed screens	60	27
Pyroguard T-EW60/6 VI (IGU) †	Multiple Paned Steel framed screens	60	28
Pyroguard T-EW60/6 VF RV (66.2) †	Multiple Paned Steel framed screens	60	29
Pyroguard T-EW60/6 VF RV (66.2) †	Multiple Paned Steel framed screens	60	30
Pyroguard T-E 30/8/10/12/19	Steel framed doorsets	30	31
Pyroguard T-E 30/8/10/12/19	Steel framed doorsets	30	32
Pyroguard T-E 30/8, T-E60/8, T-E90/8 and T-E120/8	Steel doorsets	30, 60, 90 & 120	33
Pyroguard T-E 30/10/12/19	Multiple paned Steel framed screens	30	34
Pyroguard T-EW30/6 VF RV †	Multiple paned Steel framed screens	30	35

† **Note 1:** Not approved for manufacture at site E/308

***Note 2:** The fire resistant pane of the IGU construction can be used as a single glazed pane in any previously fire tested or CERTIFIRE approved system. In this case the product code will change.

Signed
D/007 – E/308

Page 4 of 35

Issued: 21st May 2015
Revised: 8th April 2021
Valid to: 27th May 2025



CERTIFICATE No CF 5319

PYROGUARD UK LIMITED

'Pyroguard T Integrity only (E) Fire Resisting Glass (continued)

General Requirements

- Where the glass is installed in a timber or steel framed screen, the orientation of the screen shall be no more than $\pm 10^\circ$ from the vertical.
- There may be a restriction to the direction of exposure for the glass, particularly with T-EW glasses. In this case the fire resistant coating must be orientated to the fire risk. (Refer to drawings for each product and frame type. Orientation may, also, be restricted by the requirements of a non-symmetrical framing system.)
- Spacer width for IGU's with single airspace can be in the range 6 mm to 18 mm. Aluminium or steel spacer bars can be used in 30 minute fire applications but only steel spacer bars for 60 minute fire applications. The IGU primary edge sealant can be Polysulfide, Silicone, Polyurethane or Hot Melt.
- Spacer widths for triple IGUs should be in the range 12-14 mm for either air space width.
- All Pyroguard T-E glasses may be substituted with thicker equivalent versions. In the case of timber applications the minimum bead dimensions must be maintained and the frame sections increase to accommodate this. In the case of steel applications the bead width may be reduced.
- Where IGUs are approved the Pyroguard T fire glass pane will be glazed on the non-fire risk side unless otherwise shown in the product drawing or by supporting test or assessment evidence.
- Pyroguard T-EW30/6 and Pyroguard T-EW60/6 has a pyrolytic coating which unless otherwise stated must be facing the inside of an IGU or the inside of a laminate and facing the fire risk in order to perform as described.
- The non-fire resistant glass counter panes used in IGU construction can be float, patterned, Georgian polished wired, toughened, and screen printed (coverage of up to 50% of glass area allowed), coated, sandblasted, acid etched but not laminated glasses unless stated.
- Triangular shapes constructed with Pyroguard T-EW30/6 VF and EW30/6 V1 with 2 x 45° corner angles or one corner truncated at 135° angle are approved but Pyroguard UK Limited should be consulted prior to specifying these products.
- Manifestation films may be applied to both the fire and non-fire risk side of the glass surface.
- For Timber framed glazing systems if the timber beads are square shaped, these may be modified (provided there is supporting test or assessment evidence for required shape).
- Where foam tape or ceramic fibre is specified as a glazing tape, Interdens intumescent strip can be used as an alternative.

Signed
D/007 – E/308

Page 5 of 35

Issued: 21st May 2015
Revised: 8th April 2021
Valid to: 27th May 2025

CERTIFICATE No CF 5319 PYROGUARD UK LIMITED

Pyroguard T-E30/8/10/12/19 glass in Hardwood framed screens for periods of 30 minutes integrity

For this application the following conditions shall apply:

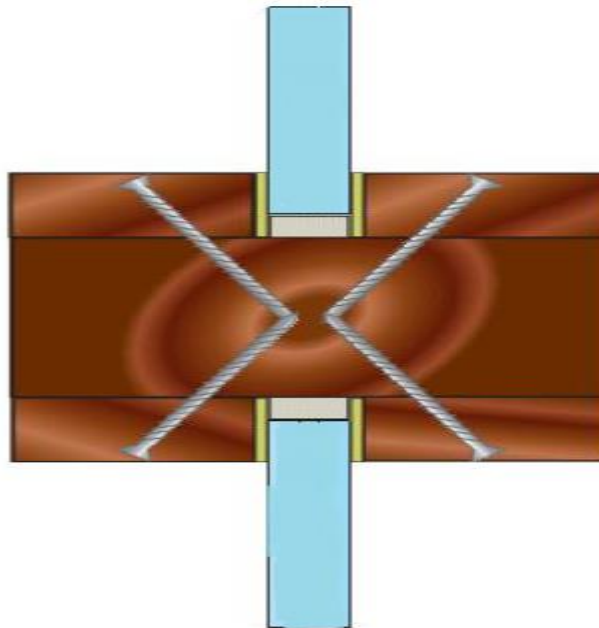

- 8mm thick toughened fire glass **Pyroguard T-E30/8** glass symmetrical glazed with one free edge.
- Framework from oak hardwood with a density of 500 kg/m³ and 86 mm x 40 mm timber profiles. Hardwood double bead system 35 mm x 20 mm with a density of 500 kg/m³. Fixed by 4 x 40 mm steel screws at 170 mm centre angled at 15°, spacing 160 mm and 70 mm from corners.
- 10 mm x 2 mm intumescent 'Intumex' (Odice) (or equivalent i.e. 'Interdens') or 'Flexpress' (Rolf Kuhn) or 20 mm x 5 mm 'Superwool' (Odice) A 10 x 2.5 mm INTUMEX LSK swelling seal was fitted at the top and bottom of the fillister of the glazing.
- 80 mm x 8 mm x 10 mm 'Superlux' setting blocks.
- Glazing and frame details as describe in **Efectis test report No 12-V-577**

Signed
D/007 – E/308

Page 6 of 35

Issued: 21st May 2015
Revised: 8th April 2021
Valid to: 27th May 2025

CERTIFICATE No CF 5319 PYROGUARD UK LIMITED

Pyroguard T-E30/8/10/12/19 glass in Hardwood framed screens for periods of 30 minutes integrity (continued)

For this application the following conditions shall apply:

The glass shall be installed within a previously fire tested hardwood framed screen utilising the following basic specification:

- **Pyroguard T-E30/8 glass**
- Glazing and frame details as described in **Efectis test report No 12-V-577**.

The hardwood framed screen shall have appropriate test or assessment evidence for the inclusions of glass of the proposed dimensions.

This Certificate of Approval relates to the sizes of glass shown in Figure 1 below, when used in conjunction with the above system.

The aspect ratio of the glass may be unlimited within these glass dimensions.

Figure 1. Maximum Permitted Glass Dimensions

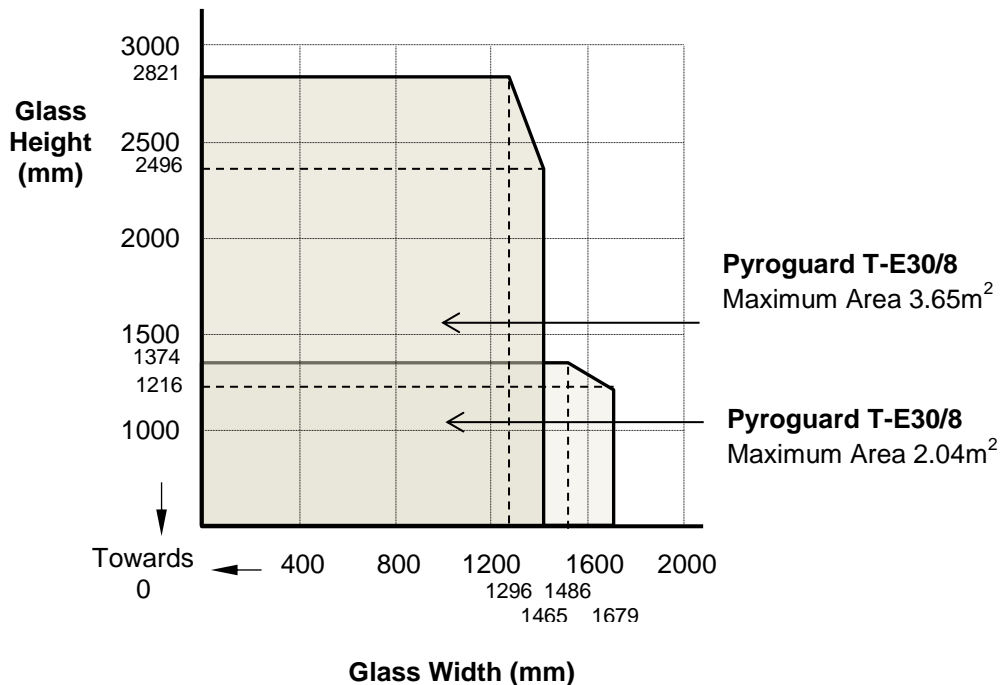

Signed
D/007 – E/308

Page 7 of 35

Issued: 21st May 2015
Revised: 8th April 2021
Valid to: 27th May 2025

CERTIFICATE No CF 5319 PYROGUARD UK LIMITED

Pyroguard T-EW30/6 or Pyroguard T-E30/6 VI RV (an IGU with steel or aluminium spacer – 6 to 18mm wide Pyroguard T-EW30/6 glass, with option of truncated corner at 135°) in Hardwood framed screens for periods of 30 minutes integrity

For this application the following conditions shall apply:

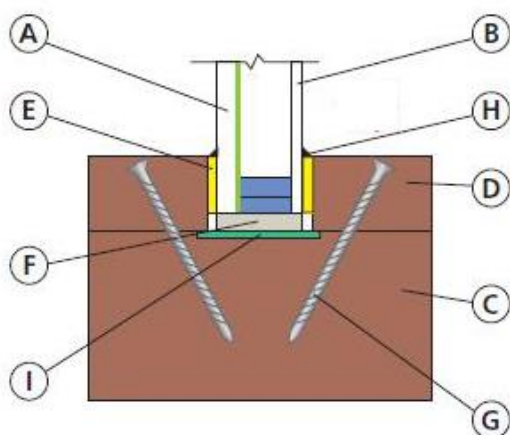

- A Pyroguard T-EW30/6 VI
- B Different options for counterface (recommendations in the test report)
- C Hardwood screen 95 x 40 mm, 630 kg/m³ minimum density
- D Hardwood beading 20 x 35 mm, 630 kg/m³ minimum density
- E Glazing material: ceramic tape
- F Setting blocks 80 x 10 x glass thickness (mm)
- G Fixings: screws 4 x 50 mm at a 45 degree angle spacings 160 mm and 70 mm from corners
- H Fire resistant silicone
- I Intumescent tape

- Pyroguard T-EW30/6 or Pyroguard T-EW30/6 VI RV with steel or aluminium spacer bar, 6 to 18mm wide. **Note:** EW30/6 has a Pyrolytic or coating on one glass face.
- Framework from Hardwood with a density of 630 kg/m³ and 95 mm x 40 mm section. Divided by 40 x 95 mm rail and styles assembled by steel screws 05 x 80 mm every 200 mm. Hardwood beads 35 mm x 20 mm with a density of 630 kg/m³. Fixed by 4 x 50 mm steel screws at 160 mm centre angled at 45° degrees glazed with one free edge.
- 10 mm x 3 mm intumescent 'Intumex' (Odice) (or equivalent i.e. Interdens) or 'Fiberfrax' (Gluske) or 15 mm x 3 mm and 10 x 2.5 mm INTUMEX LSK swelling seal fitted at the top and bottom of insulating glass unit. Glazing strips capped with 'Kerafix' (Gluske) fire resistant silicone
- 80 mm x 10 mm 'Flammi 12' setting blocks and bottom edge clearance at fillister 7.5 mm, fillister hold of the glazing 7.5 mm.
- Glazing and frame details as describe in **CTICM test report No 02-V-136 (ref 11-A-276)**

Not approved for manufacture at site E/308

Signed
D/007 – E/308

Page 8 of 35

Issued: 21st May 2015
Revised: 8th April 2021
Valid to: 27th May 2025

CERTIFICATE No CF 5319 PYROGUARD UK LIMITED

Pyroguard T-EW30/6 or Pyroguard T-E30/6 VI RV (an IGU with steel or aluminium spacer – 6 to 18mm wide, Pyroguard T-EW30/6/8/10 glass, with option of truncated corner at 135°) in Hardwood framed screens for periods of 30 minutes integrity (continued)

For this application the following conditions shall apply:

The glass shall be installed within a previously fire tested hardwood framed screen utilising the following basic specification:

- **Pyroguard T-E30/6 or Pyroguard T-E30/6 VI RV (an IGU composed of two Pyroguard T-EW30/6 panes with steel or aluminium spacer – 6 to 18mm wide, with option of truncated corner at 135°)**
- Glazing and frame details as described in **CTICM test report No 02-V-136 (ref 11-A-276)**

The hardwood framed screen shall have appropriate test or assessment evidence for the inclusions of glass of the proposed dimensions.

This Certificate of Approval relates to the sizes of glass shown in Figure 2 below, when used in conjunction with the above system.

The aspect ratio of the glass may be unlimited within these glass dimensions.

Figure 2. Maximum Permitted Glass Dimensions

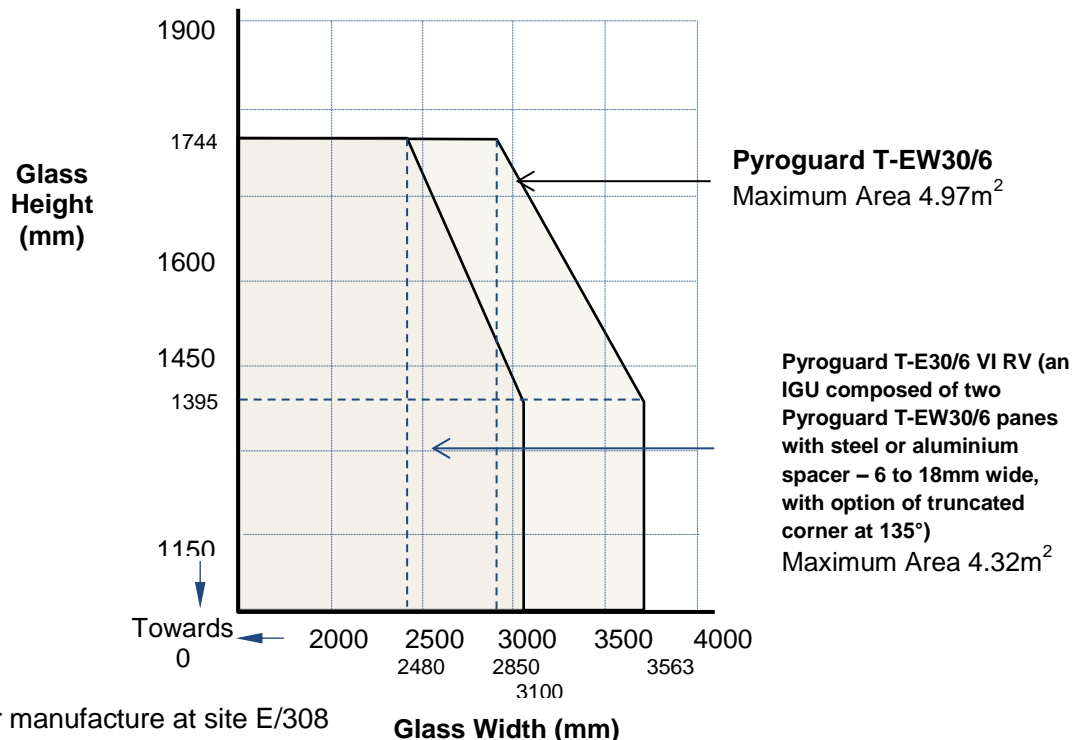

Not approved for manufacture at site E/308

Signed
D/007 – E/308

Paul Duggan

Page 9 of 35

Issued: 21st May 2015
Revised: 8th April 2021
Valid to: 27th May 2025

CERTIFICATE No CF 5319 PYROGUARD UK LIMITED

Pyroguard T-EW30/6 glass in single (Forster Presto) single steel framed screen for periods of 30 minutes integrity

For this application the following conditions shall apply:

The glass shall be installed within a previously fire tested or CERTIFIRE approved single steel framed screen utilising the following basic specification:

- **Pyroguard T-EW30/6 glass**
- Glazing and frame details as described in **CTICM test report No 01-V-197 (ref 11-A-275)**

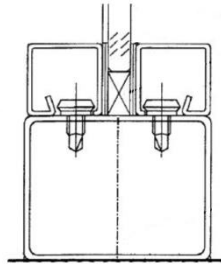

The single steel framed screen shall have appropriate test or assessment evidence or be CERTIFIRE approved for the inclusions of glass of the proposed dimensions. This Certificate of Approval relates to the sizes of glass shown in Figure 3 below, when used in conjunction with the above system. The aspect ratio of the glass may be unlimited within these glass dimensions.

Figure 3 . Maximum Permitted Glass

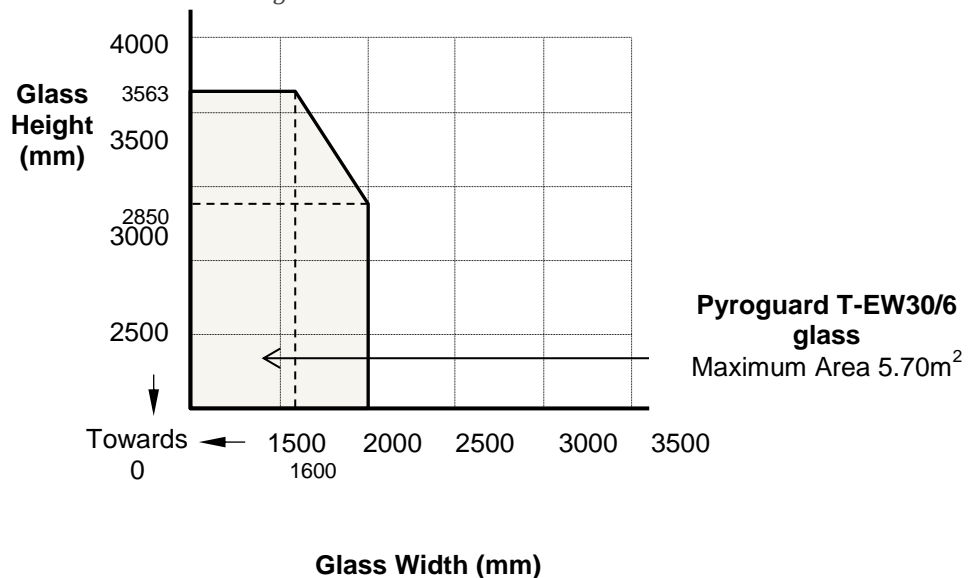

Signed
D/007 – E/308

Page 10 of 35

Issued: 21st May 2015
Revised: 8th April 2021
Valid to: 27th May 2025

CERTIFICATE No CF 5319 PYROGUARD UK LIMITED

Pyroguard T-E30/6/8/10/12/19 glass in single (Forster Presto) single steel framed screen for periods of 30 minutes integrity

For this application the following conditions shall apply:

The glass shall be installed within a previously fire tested or CERTIFIRE approved single steel framed screen utilising the following basic specification:

- **Pyroguard T-E30/6/8/10/12/19 glass,**
- Glazing and frame details as described in **CTICM test report No 01-V-135 (ref 11-A-274)**

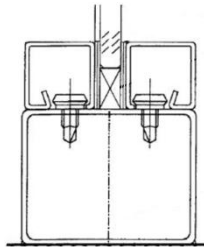

The single steel framed screen shall have appropriate test or assessment evidence or be CERTIFIRE Approved for the inclusions of glass of the proposed dimensions. This Certificate of Approval relates to the sizes of glass, shown in Figure 4 below, when used in conjunction with the above system. The aspect ratio of the glass may be unlimited within these glass dimensions.

Figure 4 . Maximum Permitted Glass Dimensions

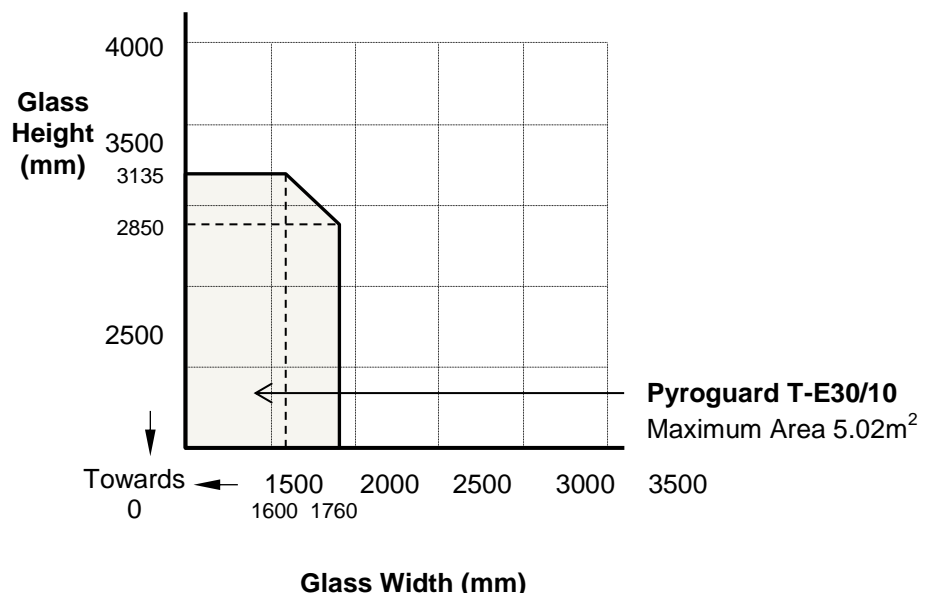

Signed
D/007 – E/308

Page 11 of 35

Issued: 21st May 2015
Revised: 8th April 2021
Valid to: 27th May 2025

CERTIFICATE No CF 5319 PYROGUARD UK LIMITED

Pyroguard T-E30/10/12/19 glass in single (Jansen Economy 50) multi-paned steel framed screen for periods of 30 minutes integrity

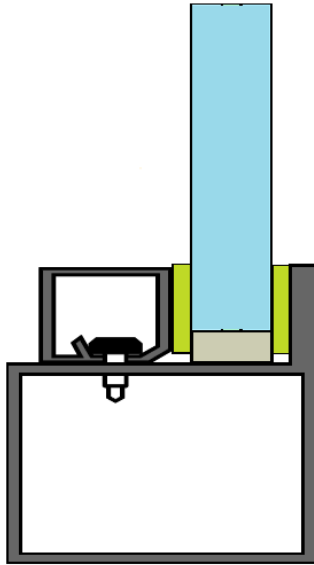

For this application the following conditions shall apply:

The glass shall be installed within a previously fire tested or CERTIFIRE approved single steel framed screen utilising the following basic specification:

- **Pyroguard T-E30/10/12/19 glass,**
- **Glazing and frame details as described in Efectis test report No EFR-17-G-003447 A**

The multi-paned steel framed screen shall have appropriate test or assessment evidence or be CERTIFIRE Approved for the inclusions of glass of the proposed dimensions. This Certificate of Approval relates to the sizes of glass, shown in the table below, when used in conjunction with the above system. The aspect ratio of the glass may be unlimited within these glass dimensions.

Maximum Permitted Glass Dimensions

	Maximum Width	Maximum Height	Maximum Area
Portrait	1603mm wide (at 2804mm) high	3271mm high (at 1374mm wide)	4.49m ²
Landscape	3271mm wide (at 1389mm) high	1620mm high (at 2804mm wide)	4.54m ²

Signed
D/007 – E/308

Page 12 of 35

Issued: 21st May 2015
Revised: 8th April 2021
Valid to: 27th May 2025

CERTIFICATE No CF 5319 PYROGUARD UK LIMITED

Pyroguard T-EW30/6 VI in a multi-paned (Jansen VISS-TV) steel glazed curtain wall system for periods of 30 minutes integrity only

For this application the following conditions shall apply:

The glass shall be installed within a previously fire tested or CERTIFIRE approved multiple paned steel framed screen utilising the following basic specification:

- **Pyroguard T-EW30/6 - steel spacer - Toughened 6 mm glass**
- Glazing and frame details as described in **CTICM test report No 03-V-346 (ref 11-A-280)**

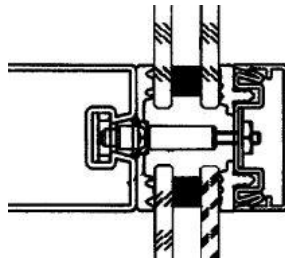

The multiple paned steel framed screens shall have appropriate test or assessment evidence or be CERTIFIRE Approved for the inclusions of glass of the proposed dimensions. This Certificate of Approval relates to the sizes of glass shown in Figure 5 below, when used in conjunction with the above system. The aspect ratio of the glass may be unlimited within these glass dimensions.

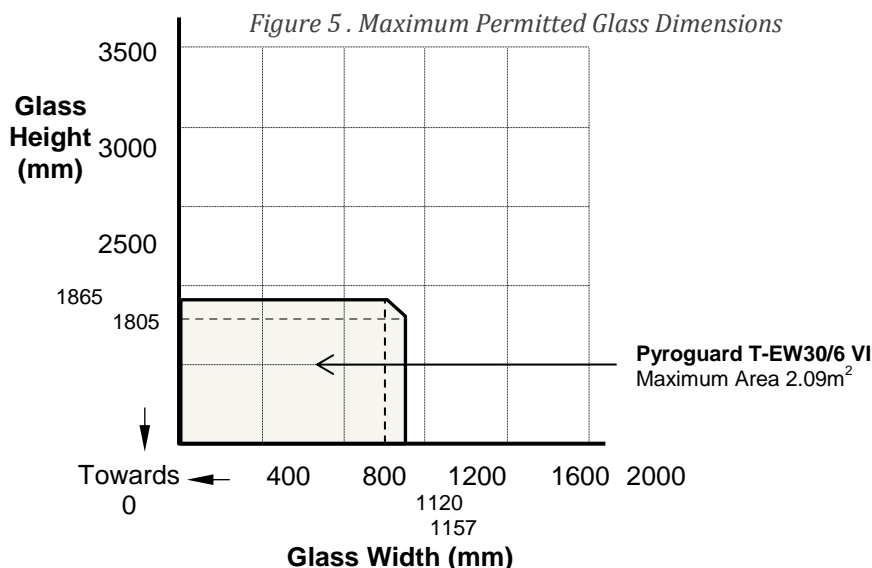

Not approved for manufacture at site E/308

Signed
D/007 – E/308

Page 13 of 35

Issued: 21st May 2015
Revised: 8th April 2021
Valid to: 27th May 2025

CERTIFICATE No CF 5319 PYROGUARD UK LIMITED

Pyroguard T-EW30/6 or Pyroguard T-E30/6 VI RV (an IGU composed of two Pyroguard T-EW30/6 panes with steel or aluminium spacer of dimensions 6 to 18mm wide) in a multi-paned (Jansen VISS-TV) steel glazed curtain walling system for periods of 30 minutes integrity only

For this application the following conditions shall apply:

The glass shall be installed within a previously fire tested or CERTIFIRE approved multiple paned steel framed screens utilising the following basic specification:

- **Pyroguard T EW30/6 – steel or aluminium spacer - Pyroguard T-EW30/6 glass**
- Glazing and frame details as described in **CTICM test report No 03-V-346 (ref11-A-280)**

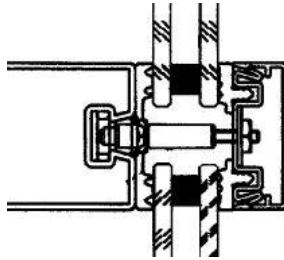

The multiple paned steel framed screens shall have appropriate test or assessment evidence or be CERTIFIRE Approved for the inclusions of glass of the proposed dimensions. This Certificate of Approval relates to the sizes of glass shown in Figure 6 below, when used in conjunction with the above system. The aspect ratio of the glass may be unlimited within these glass dimensions.

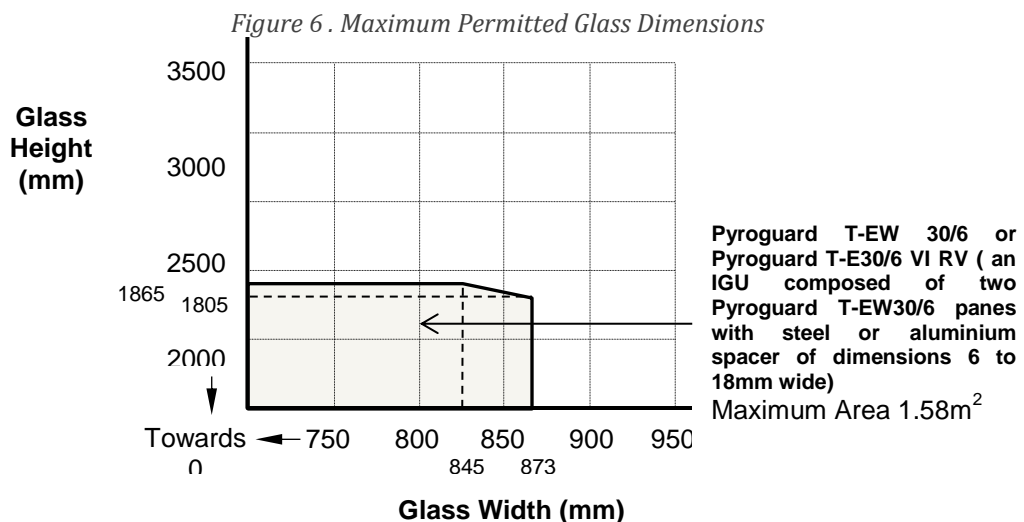

Not approved for manufacture at site E/308

Signed
D/007 – E/308

Page 14 of 35

Issued: 21st May 2015
Revised: 8th April 2021
Valid to: 27th May 2025

CERTIFICATE No CF 5319 PYROGUARD UK LIMITED

Pyroguard T-EW 30/6 VI (an IGU composed of Pyroguard T-EW30/6 pane with steel or aluminium spacer of dimensions 6 to 18mm wide and a counterpane of choice) in a multi-paned (Jansen VISS-TV) steel glazed curtain walling system for periods of 30 minutes integrity only

For this application the following conditions shall apply:

The glass shall be installed within a previously fire tested or CERTIFIRE approved multiple paned steel framed screens utilising the following basic specification:

- **Pyroguard T-EW 30/6 VI (an IGU composed of Pyroguard T-EW30/6 pane with steel or aluminium spacer of dimensions 6 to 18mm wide and a counterpane of choice)**
- Glazing and frame details as described in **CTICM test report No 03-V-346 (ref 11-A-280)**

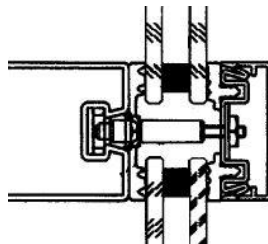

The multiple paned steel framed screens shall have appropriate test or assessment evidence or be CERTIFIRE Approved for the inclusions of glass of the proposed dimensions. This Certificate of Approval relates to the sizes of glass shown in Figure 7 below, when used in conjunction with the above system.

The aspect ratio of the glass may be unlimited within these glass dimensions.

Figure 7. Maximum Permitted Glass Dimensions

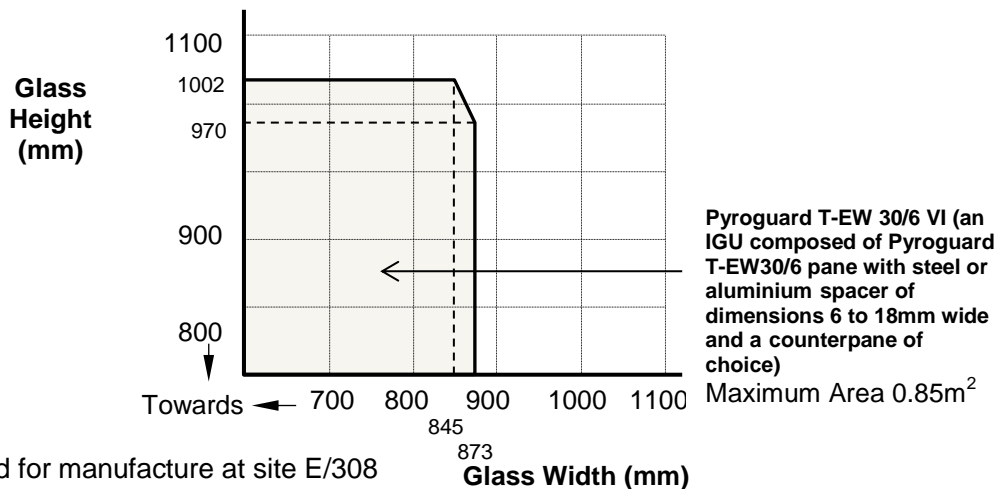

Signed
D/007 – E/308

Page 15 of 35

Issued: 21st May 2015
Revised: 8th April 2021
Valid to: 27th May 2025

CERTIFICATE No CF 5319 PYROGUARD UK LIMITED

Pyroguard T-E30/6/8/10/12/19 VI (an IGU composed of Pyroguard T-E30 with steel or aluminium space of dimensions 6mm to 18 mm and counterpane of choice) in a multi-paned (Jansen VISS-TV) steel glazed curtain wall system for periods of 30 minutes integrity only

For this application the following conditions shall apply:

The glass shall be installed within a previously fire tested or CERTIFIRE approved multiple paned steel framed screens utilising the following basic specification:

- Pyroguard T-E30/6/8/10/12/19 VI (an IGU composed of Pyroguard T-E30 with steel or aluminium space of dimensions 6mm to 18 mm and counterpane of choice)
- Glazing and frame details as described in CTICM test report No 03-V-308 (ref 11-A-279)

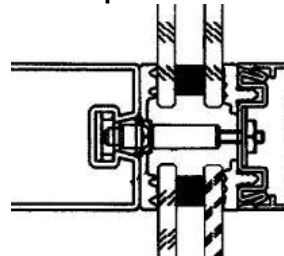

The multiple paned steel framed screens shall have appropriate test or assessment evidence or be CERTIFIRE Approved for the inclusions of glass of the proposed dimensions. This Certificate of Approval relates to the sizes of glass shown in Figure 8 below, when used in conjunction with the above system. The aspect ratio of the glass may be unlimited within these glass dimensions.

Figure 8. Maximum Permitted Glass Dimensions

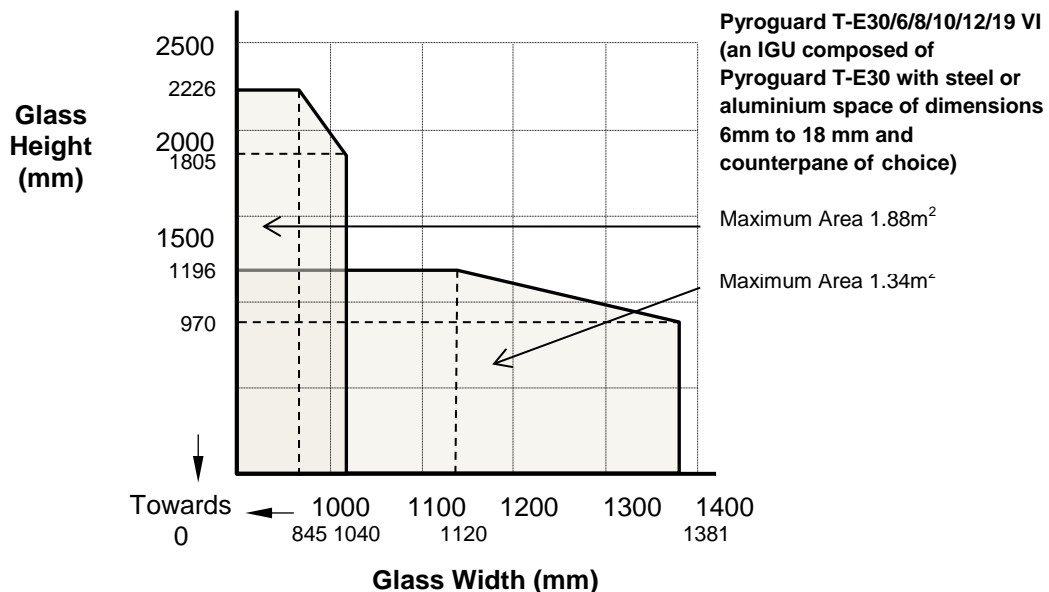

Signed
D/007 – E/308

Page 16 of 35

Issued: 21st May 2015
Revised: 8th April 2021
Valid to: 27th May 2025

CERTIFICATE No CF 5319 PYROGUARD UK LIMITED

Pyroguard T-E30/6/8/10/12/19 VI RV (an IGU composed of Pyroguard T-E30 with steel or aluminium space of dimensions 6mm to 18 mm and counterpane Pyroguard T-E30/6) in a multi-paned (Jansen VISS-TV) steel glazed curtain wall system for periods of 30 minutes integrity only

For this application the following conditions shall apply:

The glass shall be installed within a previously fire tested or CERTIFIRE approved multiple paned steel framed screens utilising the following basic specification:

- Pyroguard T-E30/6/8/10/12/19 VI RV (an IGU composed of Pyroguard T-E30 with steel or aluminium space of dimensions 6mm to 18 mm and counterpane Pyroguard T-E30/6)
- Glazing and frame details as described in CTICM test report No 03-V-308 (ref 11-A-279)

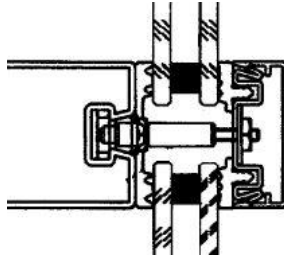

The multiple paned steel framed screens shall have appropriate test or assessment evidence or be CERTIFIRE Approved for the inclusions of glass of the proposed dimensions. This Certificate of Approval relates to the sizes of glass shown in Figure 9 below, when used in conjunction with the above system. The aspect ratio of the glass may be unlimited within these glass dimensions.

Figure 9. Maximum Permitted Glass Dimensions

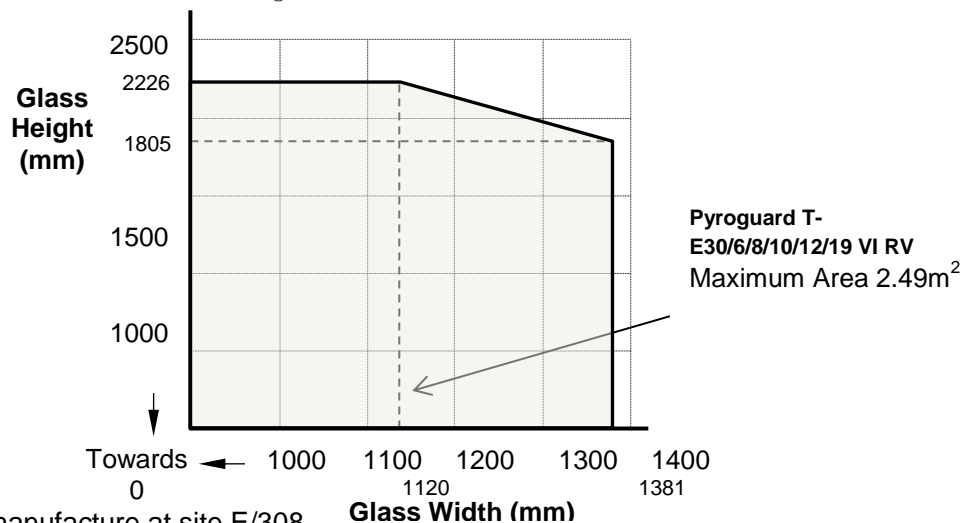

Not approved for manufacture at site E/308

Signed
D/007 – E/308

Page 17 of 35

Issued: 21st May 2015
Revised: 8th April 2021
Valid to: 27th May 2025

CERTIFICATE No CF 5319 PYROGUARD UK LIMITED

Pyroguard T-E30/6/8/10/12/19 glass in a steel multi-paned steel glazed screen for periods of 30 minutes integrity only

For this application the following conditions shall apply:

The glass shall be installed within a previously fire tested or CERTIFIRE approved multiple paned steel framed screens utilising the following basic specification:

- **Pyroguard T-E30/6/10/12/19 mm glass**
- Glazing and frame details as described in **CTICM test report No 02-V-444 (ref 11-A-277)**

It is additionally approved that this glass may be sandblasted on one or both sides at the sizes below..

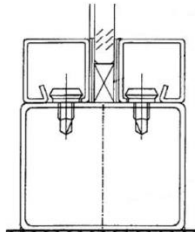

The multi-paned steel framed screens shall have appropriate test or assessment evidence or be CERTIFIRE Approved for the inclusions of glass of the proposed dimensions. This Certificate of Approval relates to the sizes of glass shown in Figure 10 below, when used in conjunction with the above system. The aspect ratio of the glass may be unlimited within these glass dimensions.

Figure 10. Maximum Permitted Glass Dimensions

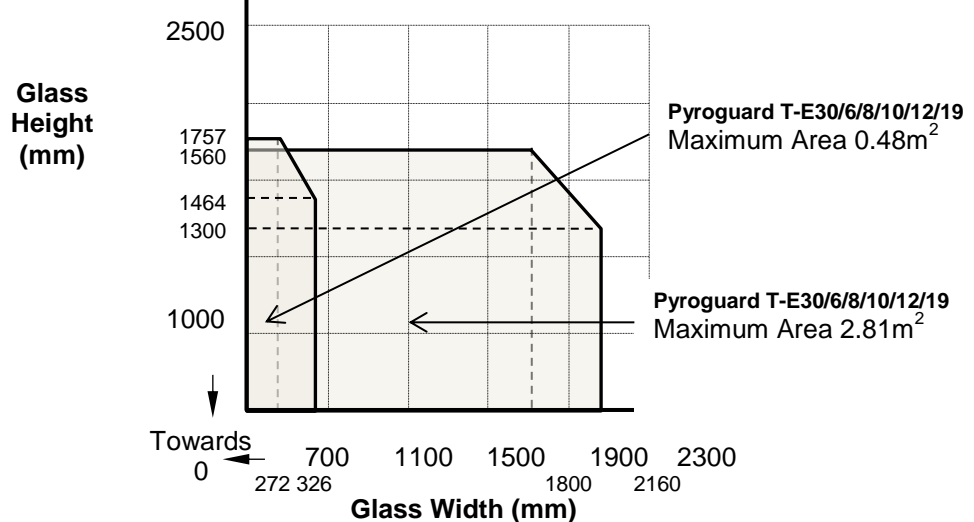

Signed
D/007 – E/308

Page 18 of 35

Issued: 21st May 2015
Revised: 8th April 2021
Valid to: 27th May 2025

CERTIFICATE No CF 5319 PYROGUARD UK LIMITED

Pyroguard T-E30/6/8/10/12/19 glass with option of printed surface cover of up to 50% of area, to fire or non - fire side glazed in a steel multi-paned steel glazed screen for periods of 30 minutes integrity only

For this application the following conditions shall apply:

The glass shall be installed within a previously fire tested or CERTIFIRE approved multiple paned steel framed screens utilising the following basic specification:

- **Pyroguard T-E30/6/8/10/12/19 glass with option of printed surface cover of up to 50% of area on fire or non-fire side**
- Glazing and frame details as described in **CTICM test report No 02-V-444 (ref 11-A-277)**

It is additionally approved that this glass may be printed on the fire or non-fire side up to 50% of the glass area.

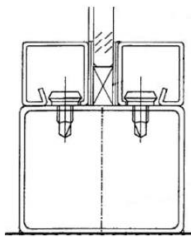

The multiple paned steel framed screens shall have appropriate test or assessment evidence or be CERTIFIRE Approved for the inclusions of glass of the proposed dimensions. This Certificate of Approval relates to the sizes of glass shown in Figure 11 below, when used in conjunction with the above system.

The aspect ratio of the glass may be unlimited within these glass dimensions.

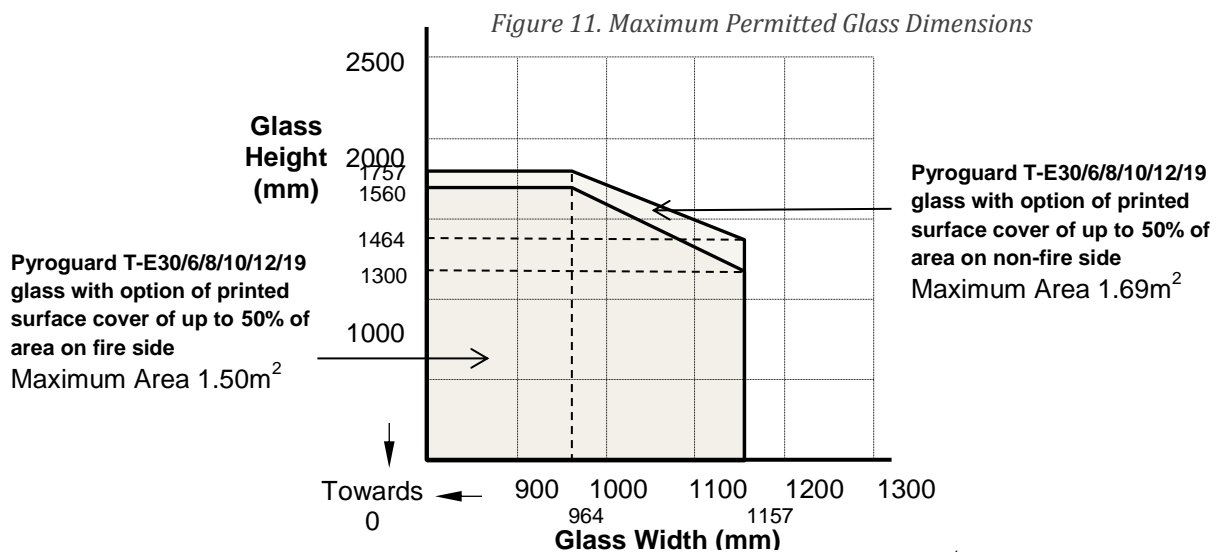

Signed
D/007 – E/308

Page 19 of 35

Issued: 21st May 2015
Revised: 8th April 2021
Valid to: 27th May 2025

CERTIFICATE No CF 5319 PYROGUARD UK LIMITED

Pyroguard T-E30/6/8/10/12/19 VF RV as part of a laminated pane, i.e.66.2, in a multi-paned steel glazed screen for periods of 30 minutes integrity only

For this application the following conditions shall apply:

The glass shall be installed within a previously fire tested or CERTIFIRE approved multiple paned steel framed screens utilising the following basic specification:

- **Pyroguard T-E30/6/8/10/12/19 VF RV i.e. 66.2**
- Glazing and frame details as described in **CTICM test report No 02-V-444 (ref 11-A-277)**

It is additionally approved that this glass may be printed on the fire or non-fire side up to 50% of the glass area.

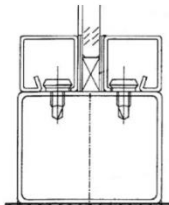

The multiple paned steel framed screens shall have appropriate test or assessment evidence or be CERTIFIRE Approved for the inclusions of glass of the proposed dimensions. This Certificate of Approval relates to the sizes glass shown in Figure 12 below, when used in conjunction with the above system. The aspect ratio of the glass may be unlimited within these glass dimensions.

Figure 12 . Maximum Permitted Glass Dimensions

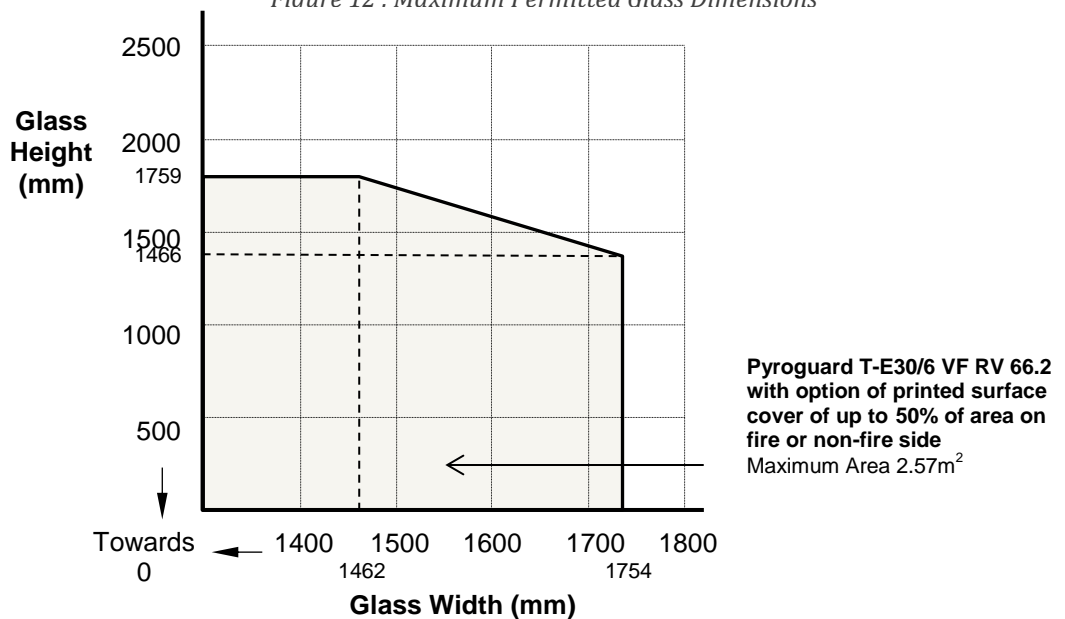

Signed
D/007 – E/308

Page 20 of 35

Issued: 21st May 2015
Revised: 8th April 2021
Valid to: 27th May 2025

CERTIFICATE No CF 5319 PYROGUARD UK LIMITED

Pyroguard T-E30/6/8/10/12/19 glass (6 mm toughened) in timber based doorsets for periods of 30 minutes integrity

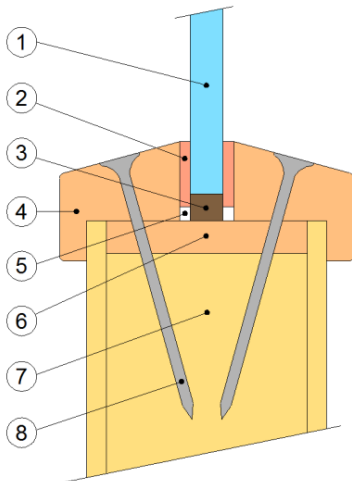

1. Pyroguard T-E30/6 glass
2. Closed cell foam glazing tape: 'FIRE + ACOUSTIC 78130', 12mm by 2 mm
3. Max 5 mm hardwood setting blocks
4. 22 mm high by 22 mm wide MDF beads including a 5 mm by 7 mm bolection, chamfered to 15°
5. Acrylic intumescent mastic to void, both sides
6. 6mm thick MDF liner to aperture (minimum density 550kg/m³)
7. Nominal 44 mm thick FD30 door leaf
8. 50 mm x 2 mm diameter steel pins at maximum of 90 mm centres, angles by 30°

Edge cover to be 8mm with minimum 2.5mm clearance at vertical edges and top edge.

The doorset shall be CERTIFIRE approved or have test evidence for the inclusion of apertures of the proposed dimensions. Only solid cored timber based or cellulosic cores are suitable for being glazed with this system.

This Certificate of Approval relates to the sizes of Pyroguard T-E30/6 glass shown in Figure 13, when used in conjunction with the above system. The aspect ratio of the glass may be unlimited within these aperture dimensions.

Figure 13. Maximum Permitted Glass Dimensions

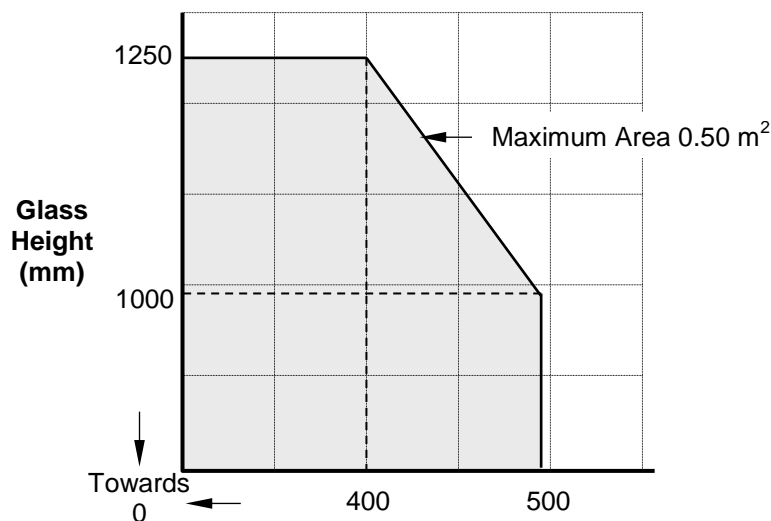

Signed
D/007 – E/308

Paul Duggan

Page 21 of 35

Issued: 21st May 2015
Revised: 8th April 2021
Valid to: 27th May 2025

CERTIFICATE No CF 5319 PYROGUARD UK LIMITED

Pyroguard T-E30/6/8/10/12/19 glass (6 mm toughened) in timber based doorsets for periods of 30 minutes integrity

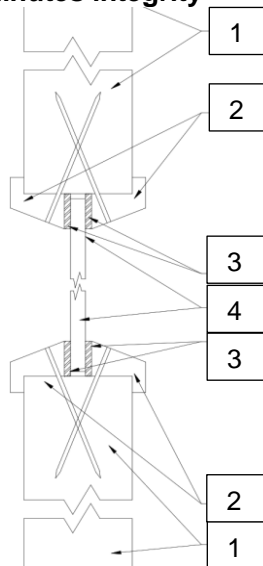

1. Nominal 44 mm thick FD30 door leaf with a 44 mm thick hardwood liner (620kg/m³) framing the perimeter of the aperture
2. MDF beads with mitred corners 22mm high by 21mm wide including a 7mm high x 6mm wide bolection, chamfer angle of 22°. Fixed using 60mmx16swg gun fired steel pins, 50 mm form corners and 100 mm centres at 30° to glass.
3. Sealmaster Intumescent Closed Cell Foam Tape, 15 mm x 3 mm uncompressed.
4. Pyroguard T-E30/6 Glass, (no setting block required)*

*Edge cover to be 11mm at head, 12mm at vertical edges and 15mm at bottom giving glass expansion allowance of 3mm each side and 4mm at top edge

Glazing and doorset details as described in test report **CFR 1906261**.

The doorset shall be CERTIFIRE approved or have test evidence for the inclusion of apertures of the proposed dimensions. Only solid cored timber based or cellulosic cores are suitable for being glazed with this system.

This Certificate of Approval relates to the sizes of Pyroguard T-E30/6 glass shown in Figure 14, when used in conjunction with the above system. The aspect ratio of the glass may be unlimited within these aperture dimensions.

Figure 14. Maximum Permitted Glass Dimensions

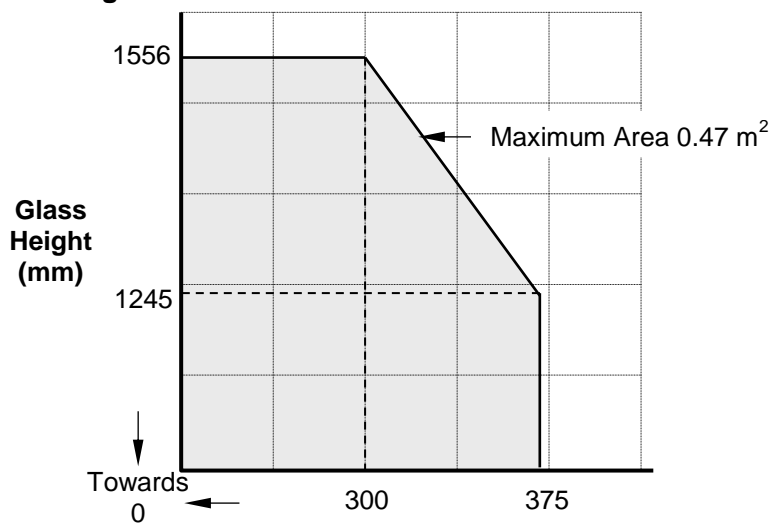

Signed
D/007 – E/308

Page 22 of 35

Issued: 21st May 2015
Revised: 8th April 2021
Valid to: 27th May 2025

CERTIFICATE No CF 5319 PYROGUARD UK LIMITED

Pyroguard T-E30/19 glass (19 mm toughened) in timber based doorsets for periods of 30 minutes integrity

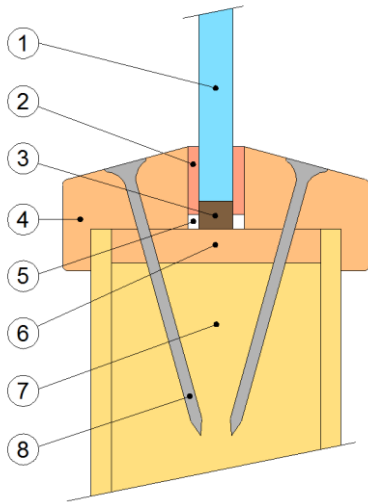

1. Pyroguard T-E30/19 glass
2. Closed cell foam glazing tape by Acoustic Seals Limited, 15mm by 3 mm
3. 20 mm x 19 mm x 3 mm hardwood setting blocks, loosely fitted underneath base of glass
4. Hardwood beads (510kg/m³), chamfered to 20° (see below for bead dimensions)
5. Firepro Acoustic acrylic intumescent mastic to void, both sides
6. 6mm thick hardwood liner to aperture (minimum density 510kg/m³)
7. Nominal 44 mm or 54 mm thick FD30 door leaf
8. 45 mm x 3.7 mm diameter brass screws at maximum of 120 mm centres, angled by 20°



Bead dimensions for 44mm thick leaf

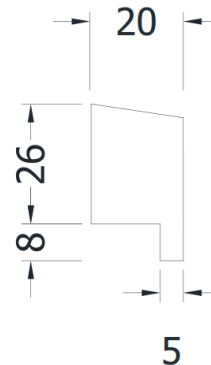

Bead dimensions for 54mm thick leaf

Edge cover to be 18mm with minimum 10mm clearance at vertical edges and top edge.

The doorset shall be CERTIFIRE approved or have test evidence for the inclusion of apertures of the proposed dimensions. Only solid cored timber based or cellulosic cores are suitable for being glazed with this system.

Signed
D/007 – E/308

Page 23 of 35

Issued: 21st May 2015
Revised: 8th April 2021
Valid to: 27th May 2025

CERTIFICATE No CF 5319 PYROGUARD UK LIMITED

Pyroguard T-E30/19 glass (19 mm toughened) in timber based doorsets for periods of 30 minutes integrity

This Certificate of Approval relates to the sizes of Pyroguard T-E30/19 glass shown in Figure 15, when used in conjunction with the above system. The aspect ratio of the glass may be unlimited within these aperture dimensions.

Figure 15. Maximum Permitted Glass Dimensions

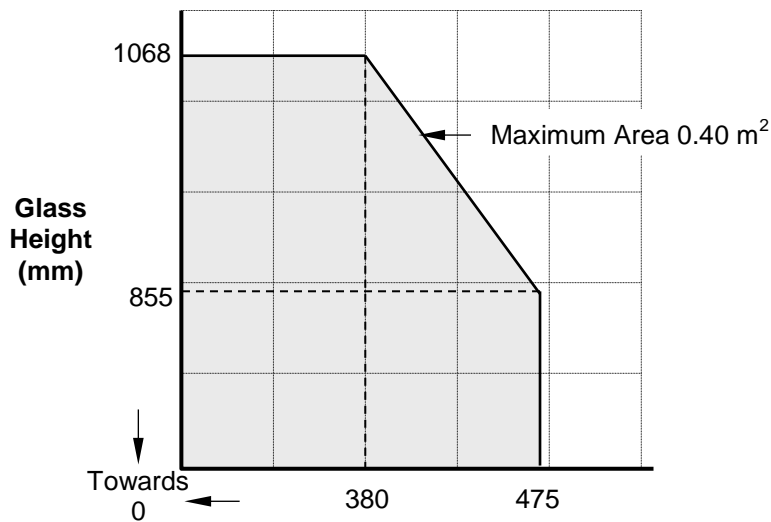

Signed
D/007 – E/308

Page 24 of 35

Issued: 21st May 2015
Revised: 8th April 2021
Valid to: 27th May 2025

CERTIFICATE No CF 5319 PYROGUARD UK LIMITED

Pyroguard T-EW60/6 VF RV as laminated 66.2 pane in timber based doorsets for periods of 60 minutes integrity

For this application the following conditions shall apply:

The glass shall be glazed within a previously fire tested or CERTIFIRE approved timber based doorset utilising the following basic specification:

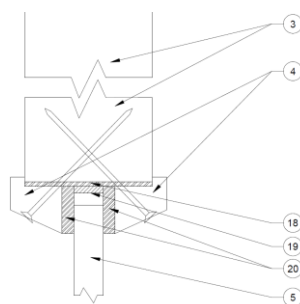

- 3 Nominally 54 mm thick FD60 door leaf
- 4 Hardwood (640 kg/m³) glazing beads, 28.5mm by 22.3mm including 8.5mm x 5.7mm bolection, chamfered at 25°
Beads fixed with No.8 x 2.5" steel countersunk screws set at 150mm centres and at 45° to the glass
- 5 Pyroguard T-EW60/6 VF RV (66.2)
Non-combustible/hardwood setting blocks 10mm (h) x 25mm (w) x 13mm (d)
- 18 Therm-A-Sol intumescent liner, 52mm x 2mm
- 19 Sealmaster FireGlaze tape, 13mm x 2.5mm
- 20 ISL 60 Plus 20mm x 5mm glazing tape

- Glazing and doorset details as described in **CFR1808152**

The doorset shall be CERTIFIRE approved or have test evidence for the inclusion of apertures of the proposed dimensions.

Maximum Permitted Glass Dimensions

Maximum Width	Maximum Height	Maximum Area
398mm wide (at 1602mm) high	1815mm high (at 351mm wide)	0.63m ²

Not approved for manufacture at site E/308

Signed
D/007 – E/308

Page 25 of 35

Issued: 21st May 2015
Revised: 8th April 2021
Valid to: 27th May 2025

CERTIFICATE No CF 5319 PYROGUARD UK LIMITED

Pyroguard T-EW60/6 VI VF RV (an IGU composed of a fire resistant 66.2 laminate and counter pane of choice) in timber based doorsets for periods of 60 minutes integrity only

For this application the following conditions shall apply:

The glass shall be glazed within a previously fire tested or CERTIFIRE approved timber based doorset utilising the following basic specification:

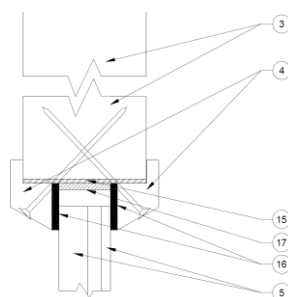

- 3 Nominally 54 mm thick FD60 door leaf
- 4 Hardwood (640 kg/m³) glazing beads, 29.5mm by 18.7mm including 10mm x 5.5mm bolection, chamfered at 20°
Beads fixed with No.8 x 2.5" steel countersunk screws set at 150mm centres and at 30° to the glass
- 5 Pyroguard T-EW60/6 VI VF RV with 6mm steel spacer and 4mm toughened glass
Non-combustible/hardwood setting blocks 10mm (h) x 25mm (w) x 13mm (d)
- 15 Therm-A-Sol intumescent liner, 54mm x 2mm
- 16 ISL 60 Plus 20mm x 5mm glazing seal
- 17 Sealmaster FireGlaze tape, 23mm x 2.5mm

- Glazing and doorset details as described in **CFR1810311**

The doorset shall be CERTIFIRE approved or have test evidence for the inclusion of apertures of the proposed dimensions. The Pyroguard T-EW60/6 VI VF RV may be glazed in either direction with respect to the fire risk.

Maximum Permitted Glass Dimensions

Maximum Width	Maximum Height	Maximum Area
374mm wide (at 1583mm) high	1794mm high (at 330mm wide)	0.59m ²

Not approved for manufacture at site E/308

Signed
D/007 – E/308

Page 26 of 35

Issued: 21st May 2015
Revised: 8th April 2021
Valid to: 27th May 2025

CERTIFICATE No CF 5319 PYROGUARD UK LIMITED

Pyroguard T-EW60/6 TVI (a triple glazed unit composed of Pyroguard T-EW60/6 - 14 mm steel spacer- counterpane of choice - 12 mm steel spacer - counterpane of choice including laminated option) in a multiple paned (Forster Unico) Glazed Screen) for periods of 60 minutes integrity only

For this application the following conditions shall apply:

The glass shall be installed within a previously fire tested or CERTIFIRE approved multiple paned steel framed screens utilising the following basic specification:

- IGU specification as described above
- Glazing and frame details as described in **Efectis 13-V-582**

The multiple paned steel framed screens shall have appropriate test or assessment evidence or be CERTIFIRE Approved for the inclusions of glass of the proposed dimensions. This Certificate of Approval relates to the sizes of triple glazed IGU shown in Figure 16 below, when used in conjunction with the above system. The aspect ratio of the glass may be unlimited within these glass dimensions.

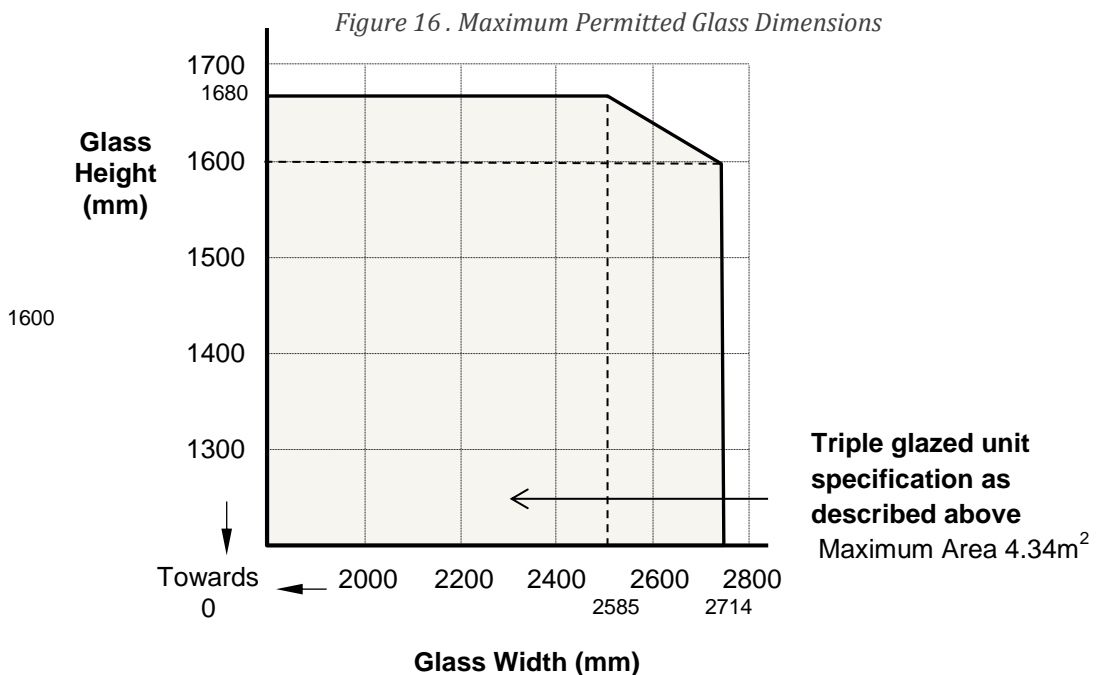

Not approved for manufacture at site E/308

Signed
D/007 – E/308

Page 27 of 35

Issued: 21st May 2015
Revised: 8th April 2021
Valid to: 27th May 2025

CERTIFICATE No CF 5319 PYROGUARD UK LIMITED

Pyroguard T-EW60/6 VI RV (an IGU composed of Pyroguard EW60/6 - 16 mm steel spacer - Pyroguard T-EW60/6 or counterpane of choice to fire side) in a multiple paned (Forster Unico) Glazed Screen for periods of 60 minutes integrity only

For this application the following conditions shall apply:

The glass shall be installed within a previously fire tested or CERTIFIRE approved multiple paned steel framed screens utilising the following basic specification:

- IGU specification as described above
- Glazing and frame details as described in **Efectis 13-V-582**

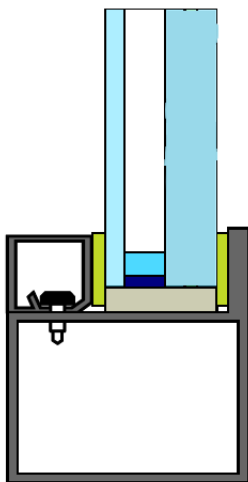

The multiple paned steel framed screens shall have appropriate test or assessment evidence or be CERTIFIRE Approved for the inclusions of glass of the proposed dimensions. This Certificate of Approval relates to the sizes of glass shown in Figure 17 below, when used in conjunction with the above system. The aspect ratio of the glass may be unlimited within these glass dimensions.

Figure 17. Maximum Permitted Glass Dimensions

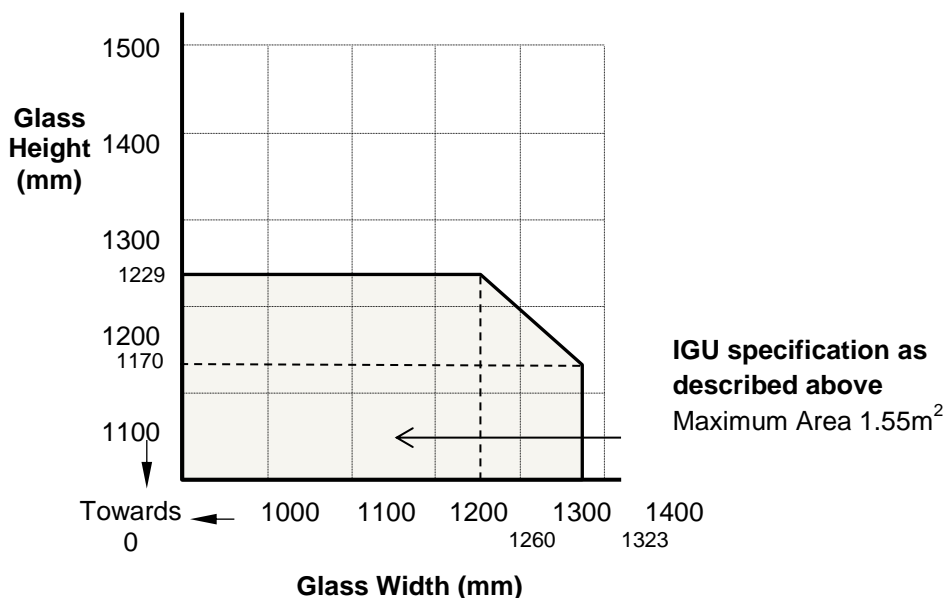

Not approved for manufacture at site E/308

Signed
D/007 – E/308

Page 28 of 35

Issued: 21st May 2015
Revised: 8th April 2021
Valid to: 27th May 2025

CERTIFICATE No CF 5319 PYROGUARD UK LIMITED

Pyroguard T-EW60/6 VF RV 66.2 in a multiple glazed (Forster Presto) Glazed Screen for periods of 60 minutes integrity

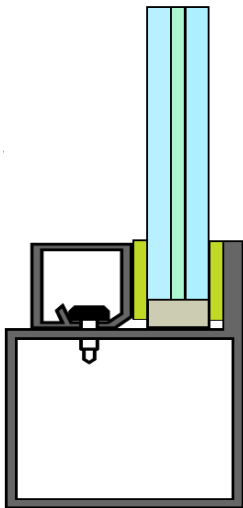

For this application the following conditions shall apply:

The glass shall be installed within a previously fire tested or CERTIFIRE approved multiple paned steel framed screens utilising the following basic specification:

- Pyroguard T-EW60/6 VF RV.
- Glazing and frame details as described in **Efectis 09-V-209**

The multiple paned steel framed screens shall have appropriate test or assessment evidence or be CERTIFIRE Approved for the inclusions of glass of the proposed dimensions. This Certificate of Approval relates to the sizes of glass shown in Figure 18 below, when used in conjunction with the above system. The aspect ratio of the glass may be unlimited within these glass dimensions.

Figure 18. Maximum Permitted Glass Dimensions

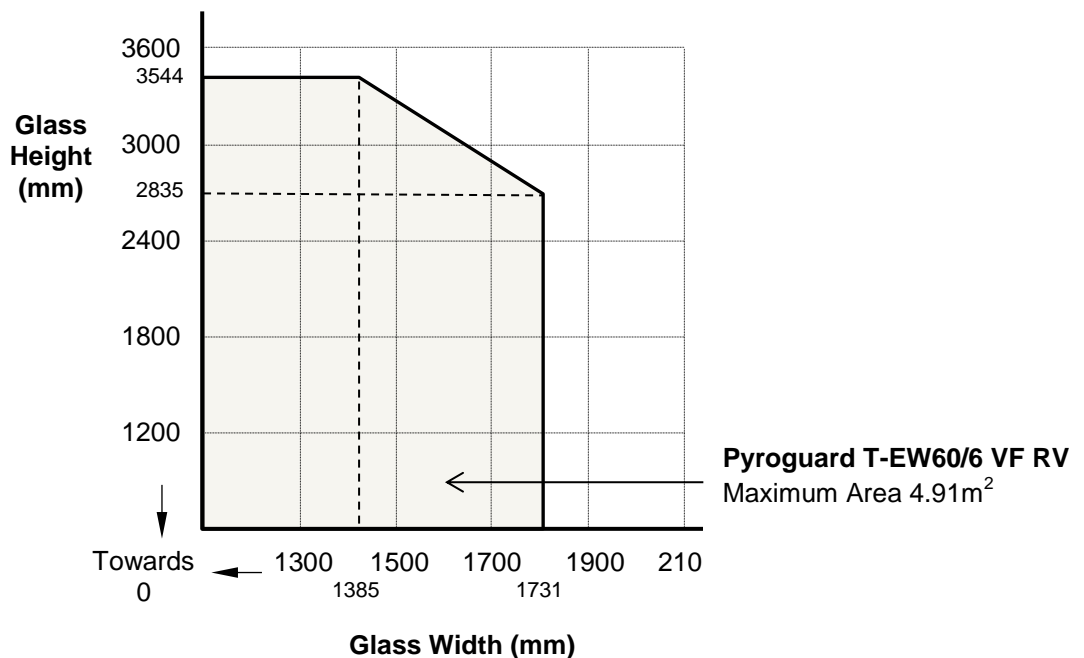

Not approved for manufacture at site E/308

Signed
D/007 – E/308

Page 29 of 35

Issued: 21st May 2015
Revised: 8th April 2021
Valid to: 27th May 2025

CERTIFICATE No CF 5319 PYROGUARD UK LIMITED

Pyroguard T-EW60/6 VF RV 66.2 glass in a multiple glazed (Forster Presto) Glazed Screen for periods of 60 minutes integrity

For this application the following conditions shall apply:

The glass shall be installed within a previously fire tested or CERTIFIRE approved multiple paned steel framed screens utilising the following basic specification:

- **Pyroguard T-EW60/6 VF RV.**
- Glazing and frame details as described in **Efectis 09-V-310**

The multiple paned steel framed screens shall have appropriate test or assessment evidence or be CERTIFIRE Approved for the inclusions of glass of the proposed dimensions. This Certificate of Approval relates to the sizes of glass shown in Figure 19 below, when used in conjunction with the above system. The aspect ratio of the glass may be unlimited within these glass dimensions.

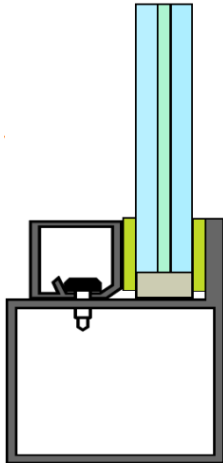
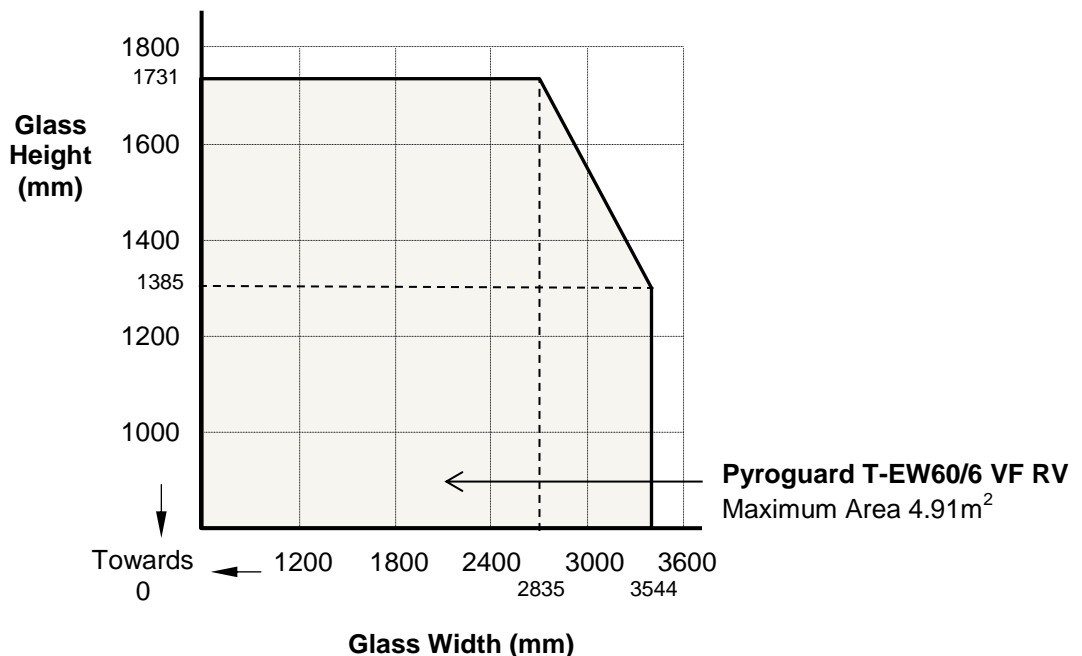

Figure 19. Maximum Permitted Glass Dimensions



Not approved for manufacture at site E/308

Signed
D/007 – E/308

Page 30 of 35

Issued: 21st May 2015
Revised: 8th April 2021
Valid to: 27th May 2025

CERTIFICATE No CF 5319 PYROGUARD UK LIMITED

Pyroguard T-E30/8/10/12/19 glass in (Forster Presto) steel framed doors (for periods of 30 minutes integrity)

For this application the following conditions shall apply:

The glass shall be installed within a previously fire tested or CERTIFIRE approved double steel door system utilising the following basic specification:

- **Pyroguard T-E30/8**
- Glazing and frame details as described in test report **CTICM 04-V-251 (ref 13-A-182)**

The steel door system shall have appropriate test or assessment evidence or be CERTIFIRE approved for the inclusions of apertures of the proposed dimensions.

- This Certificate of Approval relates to the sizes of glass shown in Figure 20 below, when used in conjunction with the above system.

The aspect ratio of the glass may be unlimited within these glass dimensions.

Figure 20 . Maximum Permitted Glass Dimensions

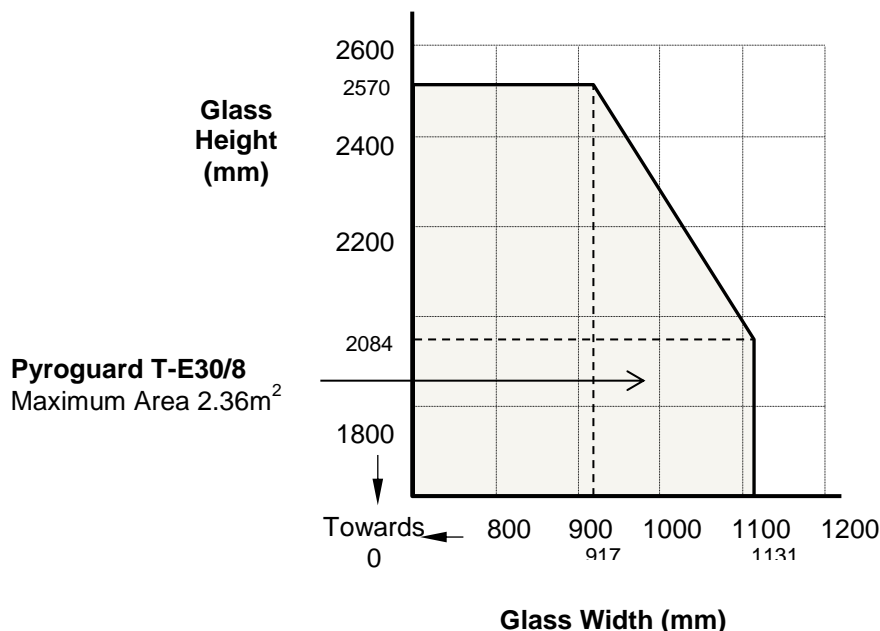

Signed
D/007 – E/308

Page 31 of 35

Issued: 21st May 2015
Revised: 8th April 2021
Valid to: 27th May 2025

CERTIFICATE No CF 5319 PYROGUARD UK LIMITED

Pyroguard T-E30/8/10/12/19 glass in (Forster Presto) steel framed doors for periods of 30 minutes integrity

For this application the following conditions shall apply:

The glass shall be installed within a previously fire tested or CERTIFIRE approved double steel door system utilising the following basic specification:

- **Pyroguard T-E30/8**
- Glazing and frame details as described in test report **CTICM 05-V-067 A (ref 13-A-175)**

The steel door system shall have appropriate test or assessment evidence or be CERTIFIRE Approved for the inclusions of apertures of the proposed dimensions.

- This Certificate of Approval relates to the sizes of glass shown in Figure 21 below, when used in conjunction with the above system.

The aspect ratio of the glass may be unlimited within these glass dimensions.

Figure 21 . Maximum Permitted Glass Dimensions

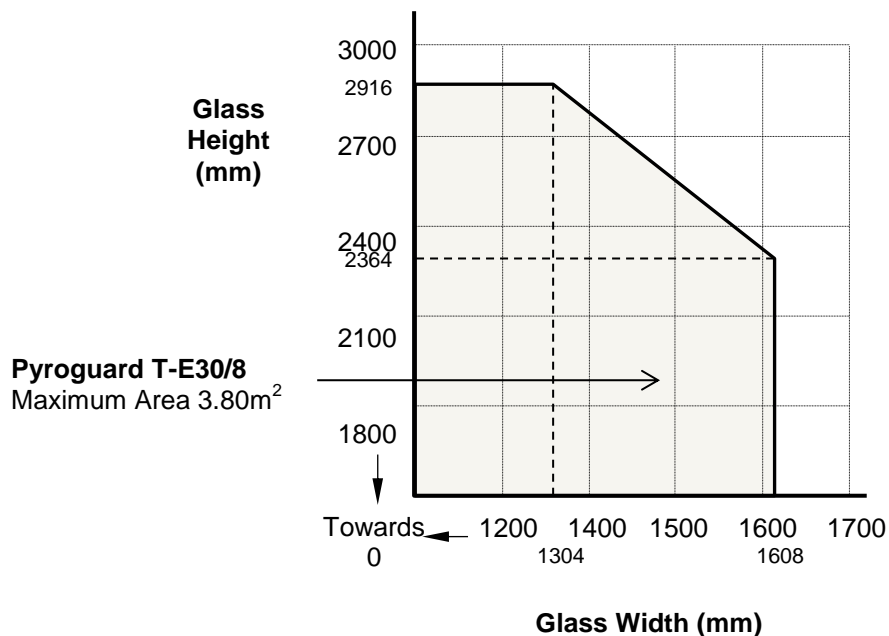

Signed
D/007 – E/308

Paul Duggan

Page 32 of 35

Issued: 21st May 2015
Revised: 8th April 2021
Valid to: 27th May 2025

CERTIFICATE No CF 5319 PYROGUARD UK LIMITED

Pyroguard T-E30/8/10/12/19 glass in steel doorsets for periods of 30, 60, 90 and 120 minutes integrity

For this application the following conditions shall apply:

The glass shall be installed within a previously fire tested or CERTIFIRE approved steel doorset system utilising the following basic specification:

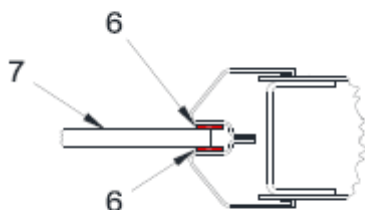

- Pyroguard T-E30/8/10/12/19
- Eurobond Doors 44mm steel door leaf
- Zeroplus FS9009 ceramic glazing tape
- Anemosta LOPRO metal bead frames

The steel door system shall have appropriate test or assessment evidence or be CERTIFIRE approved for the inclusions of apertures of the proposed dimensions.

- This Certificate of Approval relates to the sizes of glass shown in table below when used in conjunction with the above system.

The aspect ratio of the glass may be unlimited within these glass dimensions.

Maximum Permitted Glass Dimensions

Integrity Performance minutes	Maximum Width mm	Maximum Height mm	Maximum Area m ²
30 and 60	552 wide at 442 high	552 high at 442 wide	0.24
	210 wide at 1356 high	1695 high at 168 wide	0.28
90	535 wide at 442 high	535 high at 442 wide	0.23
	210 wide at 1356 high	1695 high at 168 wide	0.28
120	176 wide at 1356 high	1423 high at 168 wide	0.24

Signed
D/007 – E/308

Page 33 of 35

Issued: 21st May 2015
Revised: 8th April 2021
Valid to: 27th May 2025

CERTIFICATE No CF 5319 PYROGUARD UK LIMITED

Pyroguard T-E30/10/12/19 glass in a multiple glazed (Forster Presto) Glazed Screen for periods of 30 minutes integrity

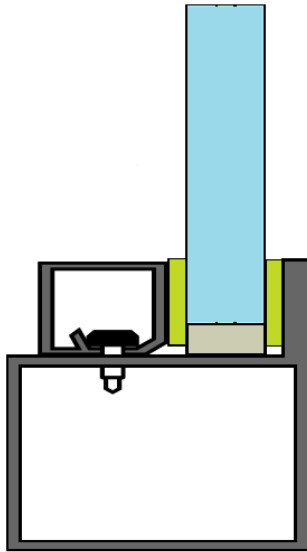

For this application the following conditions shall apply:

The glass shall be installed within a previously fire tested or CERTIFIRE approved multiple paned steel framed screens utilising the following basic specification:

- **Pyroguard T-E30/10**
- Glazing and frame details as described in **Efectis 03-G-381 A (ref 13-A-175)**

The multiple paned steel framed screens shall have appropriate test or assessment evidence or be CERTIFIRE Approved for the inclusions of glass of the proposed dimensions. This Certificate of Approval relates to the sizes of glass shown in Figure 22 below, when used in conjunction with the above system. The aspect ratio of the glass may be unlimited within these glass dimensions.

Figure 22 . Maximum Permitted Glass Dimensions

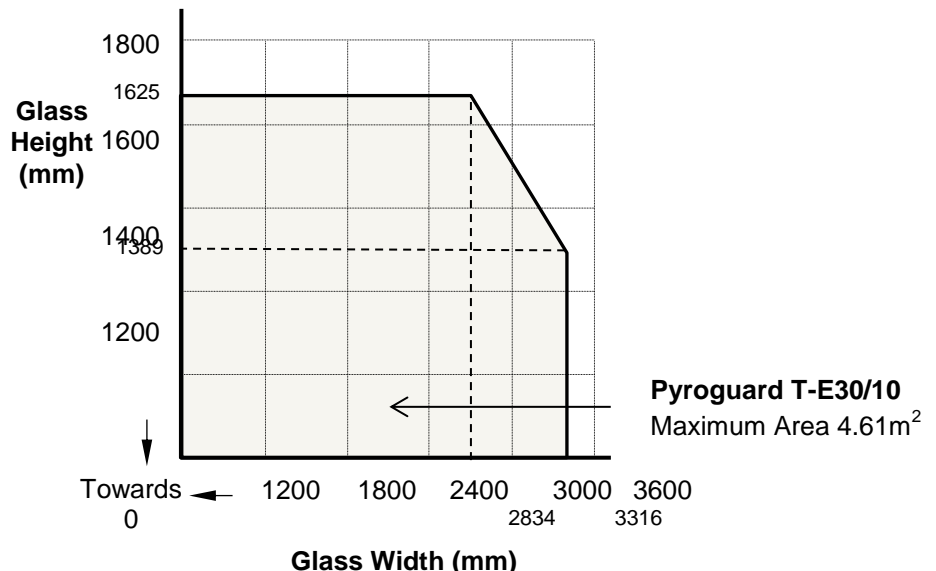

Signed
D/007 – E/308

Page 34 of 35

Issued: 21st May 2015
Revised: 8th April 2021
Valid to: 27th May 2025

CERTIFICATE No CF 5319 PYROGUARD UK LIMITED

Pyroguard T-EW30/6 VF RV 66.2 in a multiple glazed (Forster Presto) Glazed Screen for periods of 30 minutes integrity

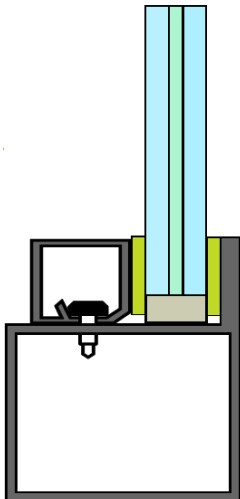

For this application the following conditions shall apply:

The glass shall be installed within a previously fire tested or CERTIFIRE approved multiple paned steel framed screens utilising the following basic specification:

- **Pyroguard T-EW30/6 VF RV a 66.2 laminated glass**
- **Glazing and frame details as described in Efectis 03-G-381 A (ref 13-A-175)**

The multiple paned steel framed screens shall have appropriate test or assessment evidence or be CERTIFIRE Approved for the inclusions of glass of the proposed dimensions. This Certificate of Approval relates to the sizes of glass shown in Figure 23 below, when used in conjunction with the above system.

The aspect ratio of the glass may be unlimited within these glass dimensions.

Figure 23 . Maximum Permitted Glass Dimensions

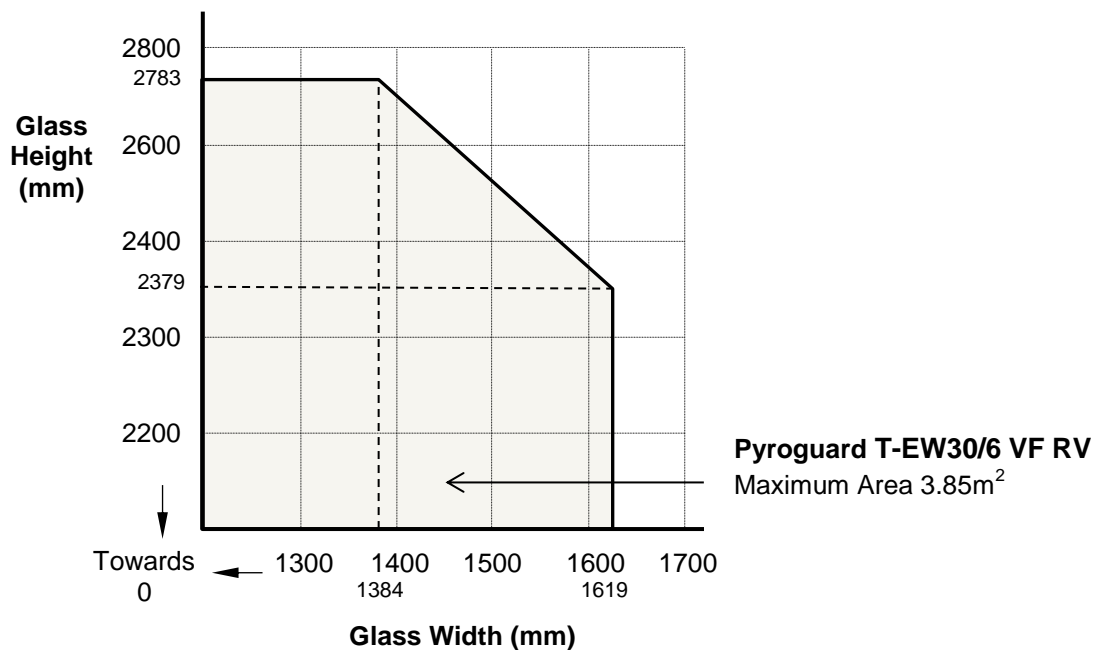

Not approved for manufacture at site E/308

Signed
D/007 – E/308

Page 35 of 35

Issued: 21st May 2015
Revised: 8th April 2021
Valid to: 27th May 2025