



# Global expertise in fire safety glass

for Schüco systems

You're in safe hands

**SCHÜCO**

## Designing with confidence: Pyroguard & Schüco solutions

With over 40 years industry experience Pyroguard fire-glass solutions have the proven capability to meet the most challenging applications creating projects that successfully combine outstanding performance with stunning aesthetics.

Similarly, since 1988, Schüco has been at the forefront of passive fire protection, offering fully tested aluminium system solutions for façades, doors, windows, and partition walls. Schüco's cutting-edge aluminium profiles, engineered to meet strict European standards, enable seamless integration across fire protection and standard areas ensuring elegant and visually uniform transitions.

Together, Pyroguard and Schüco offer a powerful combination of expertise, flexibility, and innovation, delivering reliable, high-performance solutions for projects of all sizes, worldwide.

### Why choose Pyroguard?



- ▶ Over 35 years' specialist experience
- ▶ The widest range of tested and certified products and system solutions on the market
- ▶ An abundance of knowledge and technical expertise
- ▶ Extensive test data and evidence to ensure the right solution is provided every time
- ▶ Ability to work closely with customers globally through dedicated local support
- ▶ Capacity, reach, locations and facilities to operate globally
- ▶ Independent and flexible to meet the most challenging specifications
- ▶ Up to the minute understanding of regulatory and legislative requirements to continually exceed all international standards

# Applications tables

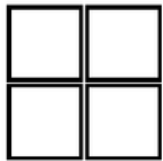

Partition wall

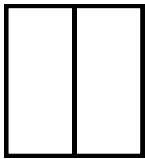

Edge to edge

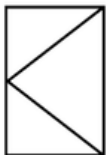

Single door

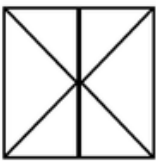

Double door

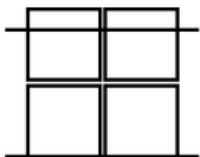

Curtain wall

## Key

DC - Dependant on the construction

VI - Double glazed insulating units



TVI - Triple glazed insulating units

VF - Laminated glasses

# Doors





Pyroguard have a range of capabilities across Schüco's ADS 80 framing system, featuring Pyroguard Protect toughened fire safety glass in EW30, EI30 and EI60 classifications for aluminium doors.

Application (System)	Classification	Max glass area (m <sup>2</sup> )	Max glass width (mm)	Max glass height (mm)	Profile	Pyroguard Glas	PV reference
 Single door	EW30	3.5	1250	2816	Schüco ADS 80 FR30	T-EW30/13-1 T-EW30/13-1 VF T-EW30/13-1 VI (counterpane to the cold side)	EXT 1 - EFR-24-000138
		3.0	1250	2418		T-EW30/13-1 VI	
	EI30	3.5	1250	2816	Schüco ADS 80 FR30	T-EI30/18-2 T-EI30/18-2 VI T-EI30/18-2 VF	EFR-24-0000138
						T-EW30/13-1 VI (counterpane to the cold side)	EXT 1 - EFR-24-000138
EI60	4.0	1454	2765	Schüco ADS 80 FR60	T-EI60/25-3 T-EI60/25-3 VF T-EI60/25-3 VI	EFR-24-0000152	
 Double door	EW30	3.5	1250	2816	Schüco ADS 80 FR30	T-EW30/13-1 T-EW30/13-1 VF T-EW30/13-1 VI (counterpane to the cold side)	EXT 1 - EFR-24-000138
		3.0	1250	2418		T-EW30/13-1 VI	
	EI30	3.5	1250	2816	Schüco ADS 80 FR30	T-EI30/18-2 T-EI30/18-2 VI T-EI30/18-2 VF	EFR-24-0000138
						T-EW30/13-1 VI (counterpane to the cold side)	EXT 1 - EFR-24-000138
EI60	2.9	1250	2390	Schüco ADS 80 FR60	T-EI60/25-3 T-EI60/25-3 VF T-EI60/25-3 VI	EFR-24-0000152	

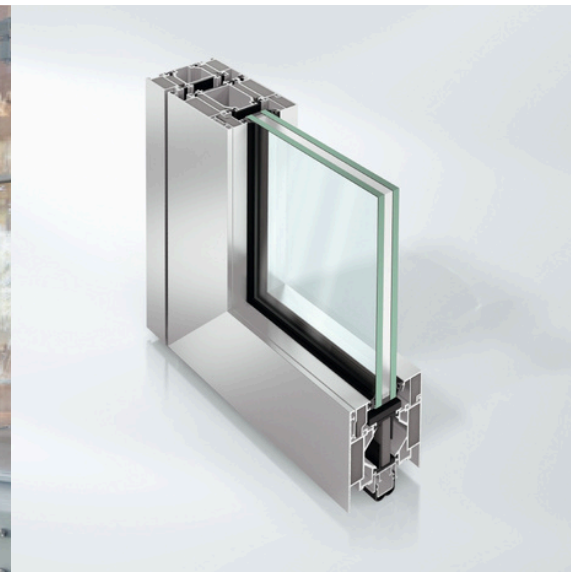
# Partitions



Pyroguard have a range of capabilities across Schüco's ADS 80 framing system, featuring Pyroguard Protect toughened fire safety glass in EW30, EI30 and EI60 classifications for aluminium partitions.

Application (System)	Classification	Max glass area (m <sup>2</sup> )	Max glass width (mm)	Max glass height (mm)	Profile	Pyroguard Glass	PV reference
 Partition wall	EW30	4.00	1643	2903	Schüco ADS 80 FR30	T-EW30/13-1 T-EW30/13-1 VF	EXT1 - EFR-24-000062
		3.06	1067	3415			
		-	2082	1200			
		-	1429	2418			
		6.12	2082	3500			
		3.40	3370	1200			
	EI30	6.07	2082	3500	Schüco ADS 80 FR30	T-EI30/18-2 T-EI30/18-2 VF T-EI30/18-2 VI (counterpane to the cold side)	EFR-24-000062
		-	1485	2735		T-EI30/18-2 VI	
		6.12	2082	3500		T-EW30/13-1 VI (counterpane to the cold side)	EXT1 - EFR-24-000062
	EI60	6.0	2076	3495	Schüco ADS 80 FR60	T-EI60/25-3 T-EI60/25-3 VF	EFR-24-000087
5.2		1596	3915	T-EI60/25-3 VI			
 Edge to edge	EI30	5.40	1800	3612	Schüco ADS 80 FR 30	T-EI30/24-2 SWS	EFR-24-001062
		6.20	1800	4080		T-EI30/32-2 SWS (angle from 0 to 180°)	EFR-24-001062

# Façades

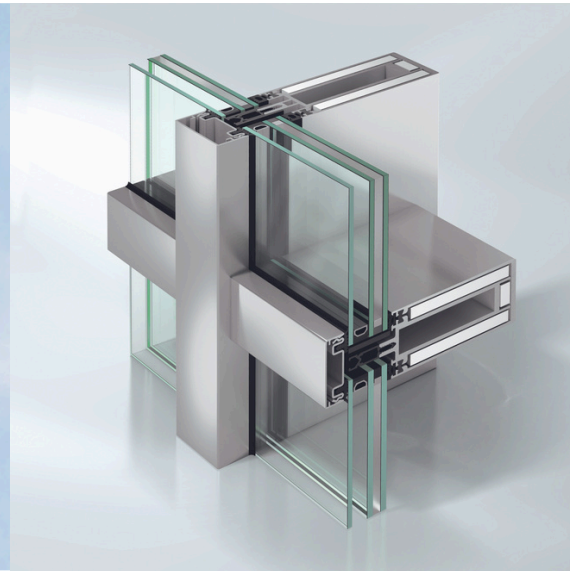

Pyroguard have a range of capabilities across Schüco's FW 50 curtain wall system, featuring Pyroguard Protect toughened fire safety glass in EI30 and EI60 classifications for aluminium façades.

Application (System)	Classification	Max glass area (m <sup>2</sup> )	Max glass width (mm)	Max glass height (mm)	Profile	Pyroguard Glas	Classification / Test Report
 Curtain wall	EI30	5.0	1680	3600	Schüco FW50+BF, FW60+BF	T-EI30/18-2 T-EI30/18-2 VF T-EI30/18-2 VI	EFR-24-002421
		5.8	1800	3883	Schüco FW50+BF, FW60+BF	T-EI30/18-2 VI (counterpane to the cold side)	EFR-24-002421
	EI60	3.9	1500	2600	Schüco FW50+BF	T-EI60/25-3 T-EI60/25-3 VF T-EI60/25-3 VI	EFR-24-002422
		4.5	1500	3000	Schüco FW50+BF	T-EI60/25-3 VI (counterpane to the cold side)	EFR-24-002422

**Pyroguard UK Ltd**

Millfield Lane  
Haydock, Merseyside  
WA11 9GA  
United Kingdom

T: [+44 \(0\)1942 710 720](tel:+44(0)1942710720)

E: [info@pyroguard.eu](mailto:info@pyroguard.eu)

[www.pyroguard.eu](http://www.pyroguard.eu)

[linkedin.com/company/pyroguard](https://www.linkedin.com/company/pyroguard)



[facebook.com/pyroguarduk](https://www.facebook.com/pyroguarduk)



[instagram.com/pyroguard](https://www.instagram.com/pyroguard)



[twitter.com/pyroguard](https://twitter.com/pyroguard)



Pyroguard

